

DUCT FANS



BFTX

AC WALL MOUNTED DUCT FANS Backward Curved

Straight airflow and easy installation to the wall - high pressure stability, low noise level and high efficiency.

Technical Drawings

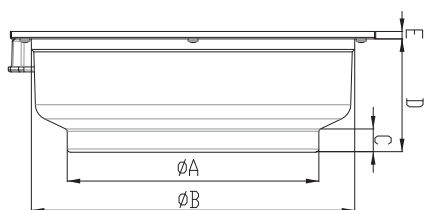
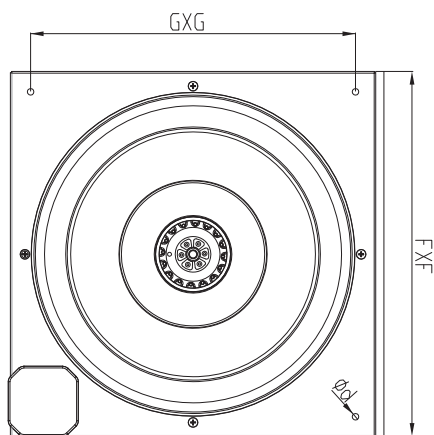

Accessories



BSC

MATERIAL

: The housing is made of electrostatic powder coated sheet iron, backward curved galvanized impeller.

INSULATION CLASS

: Class B

DIRECTIVE

: Complying with EN 60335-1, EN 60335-2-80

SPEED CONTROL

: Speed can be adjusted using an optional controller.

APPLICATION AREAS

: For industrial and constructional applications, in factories, hospitals, night clubs, offices, kitchens, bathrooms, theaters, condominiums, restaurants, etc.

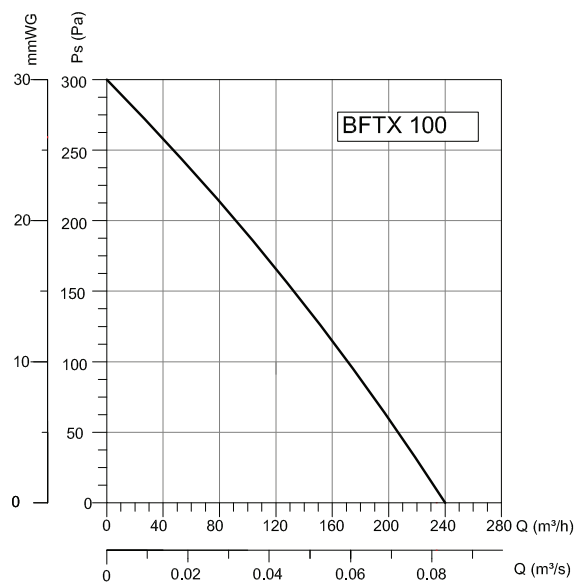

TYPE	ØA	ØB	C	D	E	F	G	d
BFTX 100	97	244	20	100	9	315	265	8
BFTX 150	147	270	24	105	9	400	350	8
BFTX 200	196	330	24	113	9	400	350	8
BFTX 250	246	330	24	116	9	400	350	8
BFTX 315	310	398	26	140	9	500	400	8

Dimensions are in (mm)

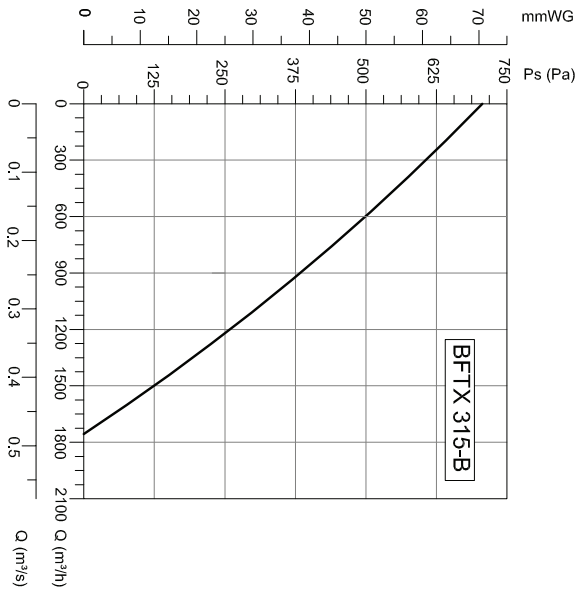
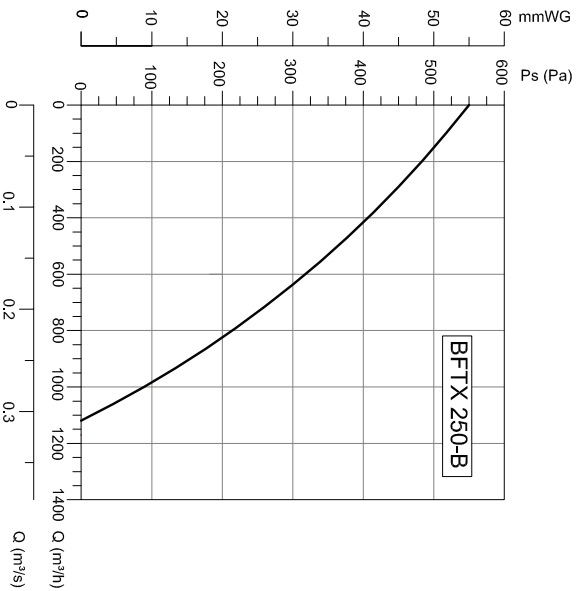
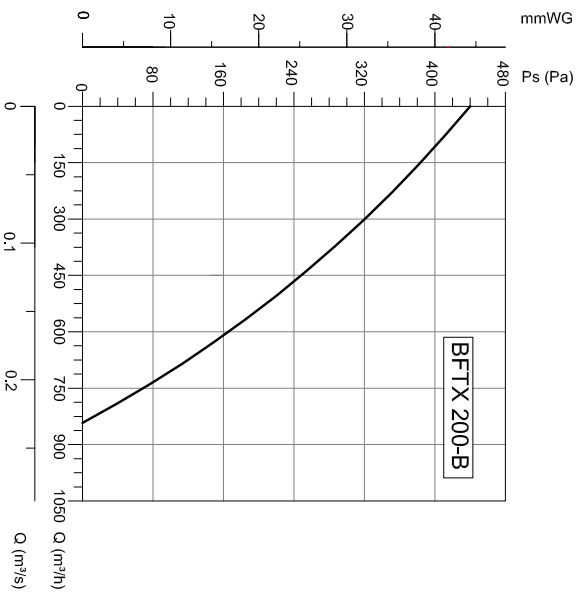
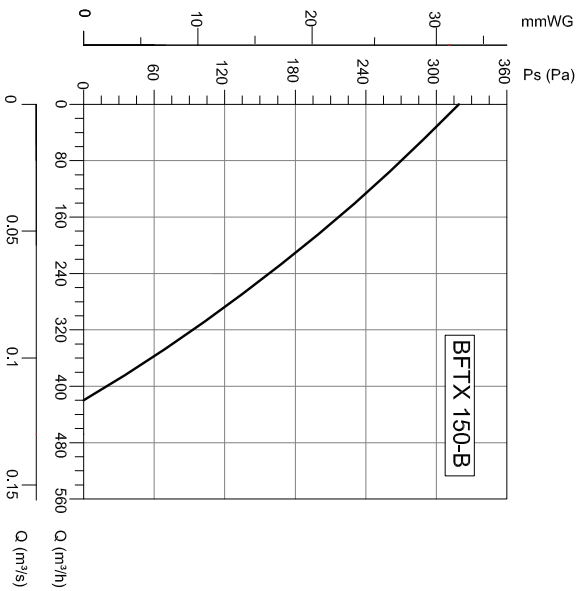

TYPE	VOLTAGE		FREQUENCY		POWER	CURRENT		CAPACITOR	SPEED	AIR FLOW	SOUND PRESSURE LEVEL	WEIGHT
	V	Hz	(A)	(A)								
BFTX 100	230	50	70	0,3	2	2540	240	50	2,7			
BFTX 150-B	230	50	85	0,38	2,5	2430	420	55	3,6			
BFTX 200-B	230	50	115	0,5	4	2600	870	56	4,8			
BFTX 250-B	230	50	135	0,59	5	2620	1150	57	5,3			
BFTX 315-B	230	50	180	0,76	7	2650	1750	65	6,6			